

Artemide®

**COME
TOGETHER**

Carlotta de Bevilacqua



COME TOGETHER

Photo by Giovanni Gastel



Artemide®

COME TOGETHER_THREE COLORS



WHITE



COPPER



ALUMINUM

COME TOGETHER

**Smart portability
(400 g)**



COME TOGETHER



Photo by Giovanni Gastel

Artemide

COME TOGETHER

**“A perfect light
and 8 hours of operation
without main power.
A new 2.0 revolution.”**

Carlotta de Bevilacqua



COME TOGETHER

3 different light performances



1,2 W

360 lx



2,4 W

680 lx



3,6 W

1000 lx

COME TOGETHER

Very high efficiency 85%



COME TOGETHER

Light collimation through
a primary optical TIR lens
and a secondary internal
white reflector

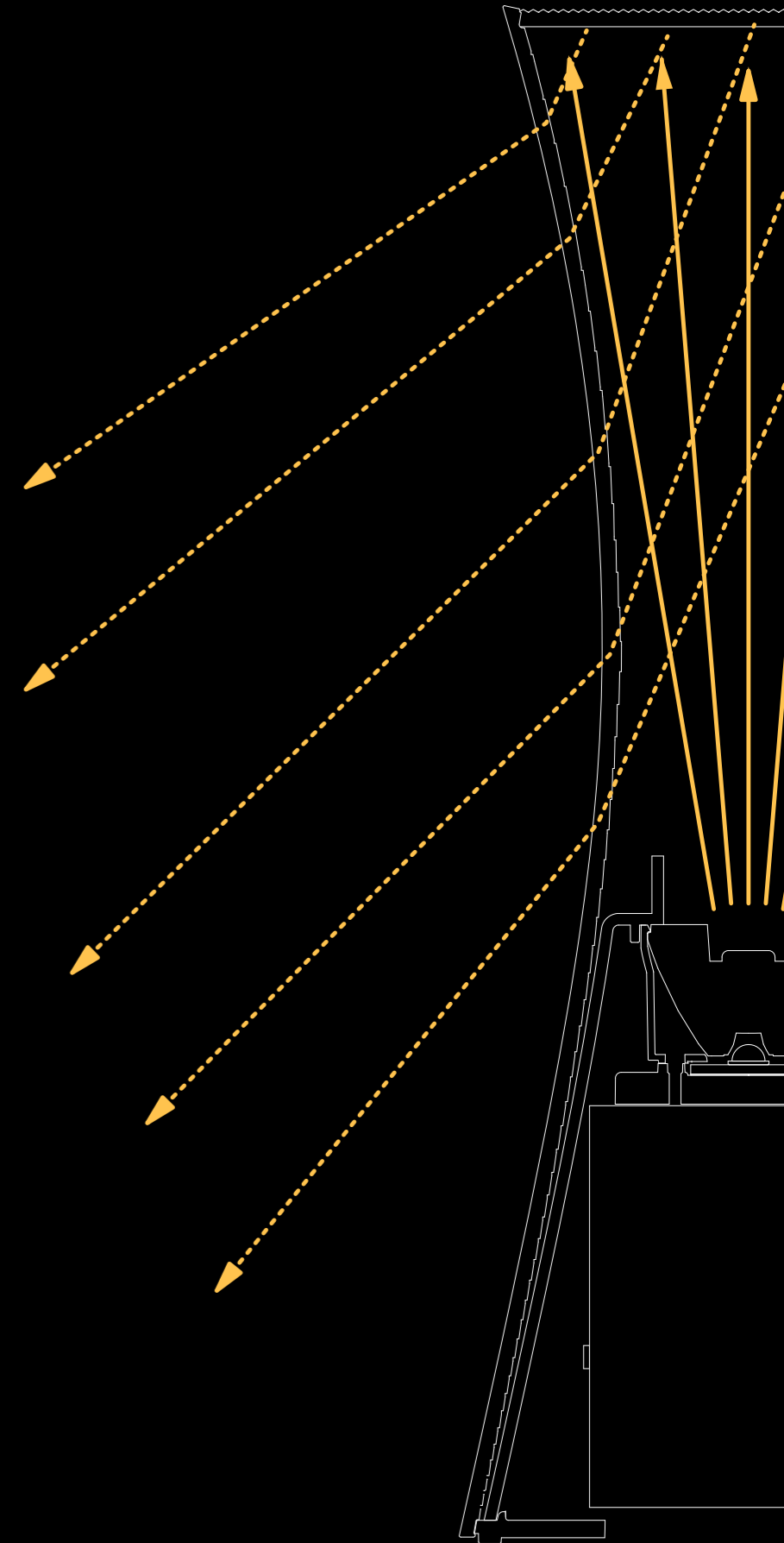

COME TOGETHER



Photo by Giovanni Gastel

Artemide

COME TOGETHER

USB port
Li-Po rechargeable
battery
8 hrs battery life
3 hrs fast charge



COME TOGETHER

1 

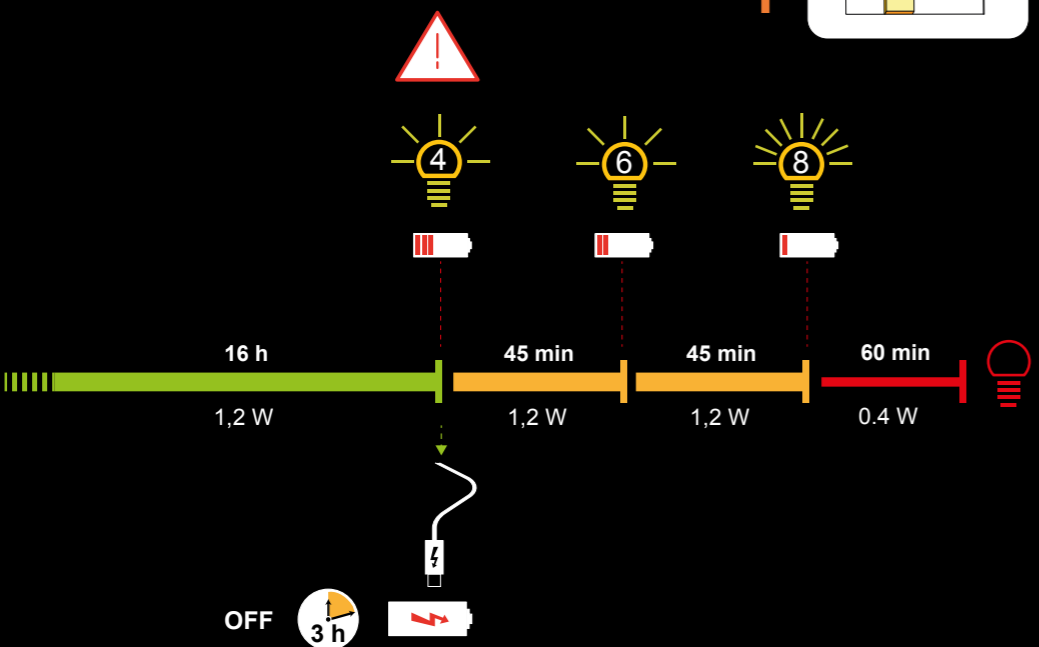

2 

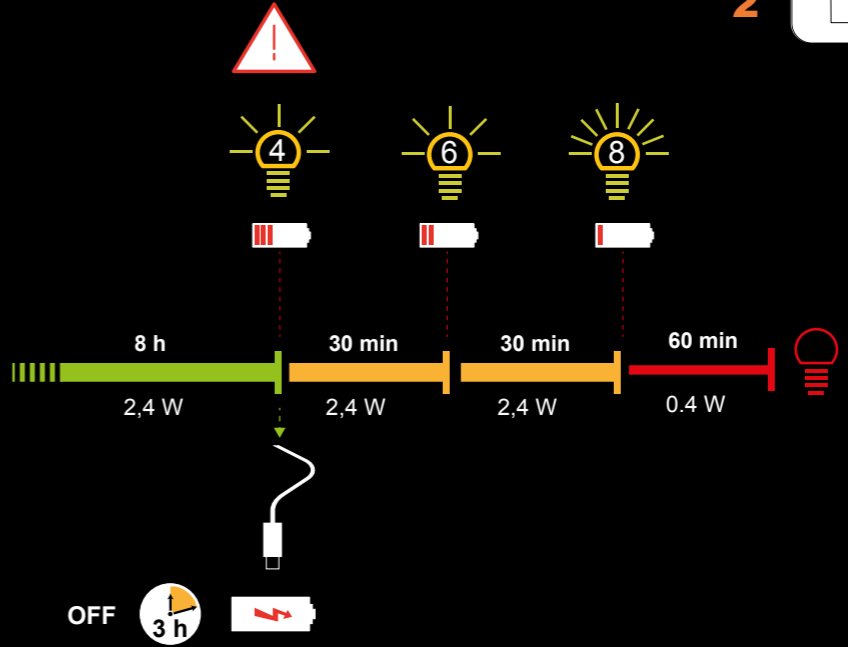

3 

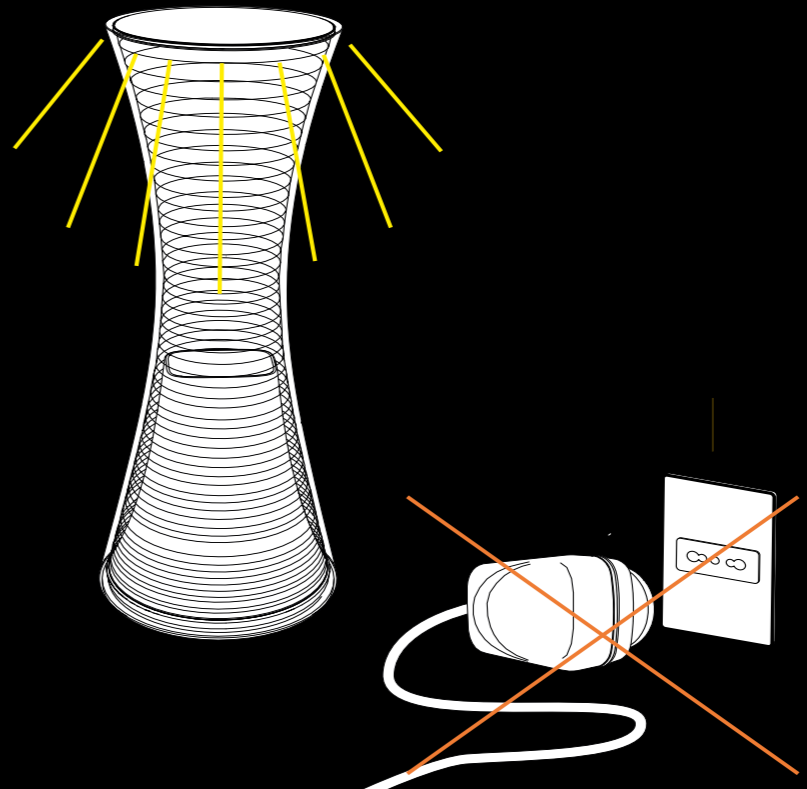
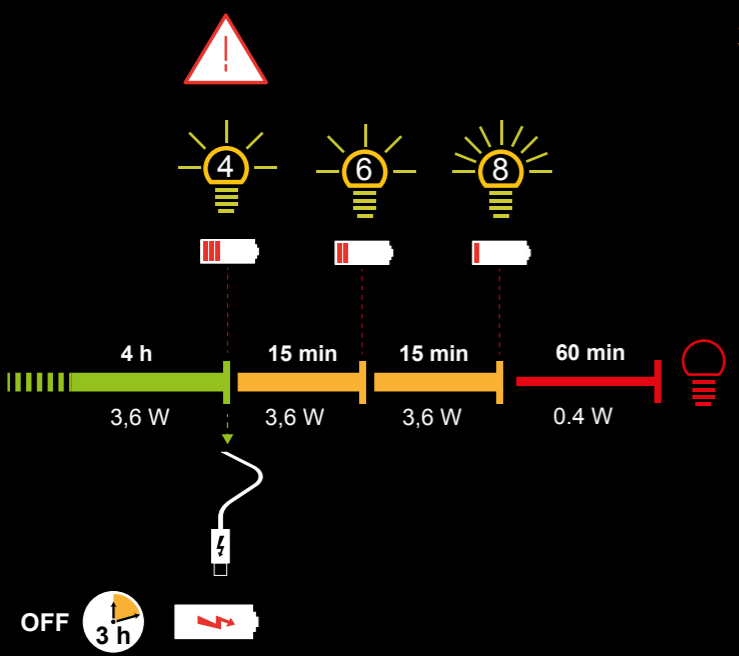

COME TOGETHER



Photo by Giovanni Gastel

Artemide

COME TOGETHER

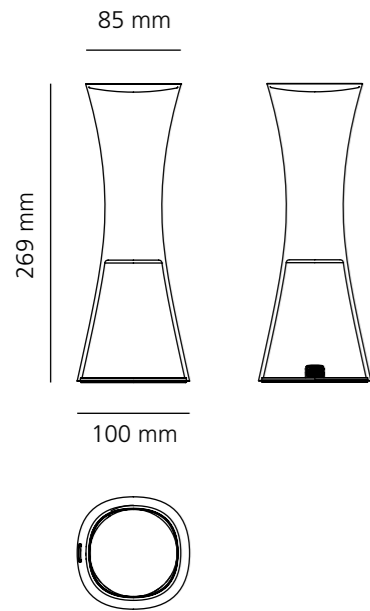

MATERIALS

transparent optical injection molded PMMA
external shell, techno-polymer internal shell

COLORS

transparent external body,
white - aluminum - copper internal shell

DIMENSIONS

ø100 mm x 269mm

TOTAL POWER

3,6W

DELIVERED LUMINOUS FLUX

250lm



CCT
3000K

CRI
80



COME TOGETHER

Carlotta de Bevilacqua

		Code	Emission	Total Power	Flux
	Come together white	0165010A	diffused light	3,6 W	250lm 3000K, CRI=80 USB recharge
	Come together aluminum	0165020A	diffused light	3,6 W	250lm 3000K, CRI=80 USB recharge
	Come together copper	0165030A	diffused light	3,6 W	250lm 3000K, CRI=80 USB recharge

